

General Specifications

Electrical Capacity (Resistive Load)

Low/Logic Level: 50mA @ 24V DC maximum for Standard Operating Force models
125mA @ 24V DC maximum for High Operating Force models

Other Ratings

	Standard Operating Force	High Operating Force
Contact Resistance:	50 milliohms maximum	50 milliohms maximum
Insulation Resistance:	500 megohms minimum @ 250V DC	500 megohms minimum @ 250V DC
Dielectric Strength:	250V AC minimum for 1 minute minimum	250V AC minimum for 1 minute minimum
Mechanical Life:	5,000,000 operations minimum	1,000,000 operations minimum
Electrical Life:	5,000,000 operations minimum	1,000,000 operations minimum
Nominal Operating Force:	1.76N for JB15L	2.65N for JB15HL & JB15HB
Total Travel:	.010" (.254mm)	.012" (.300mm)

Materials & Finishes

Actuator:	Polyacetal for Short; Glass fiber reinforced PBT for Extended
Case:	Glass fiber reinforced polyamide (UL94V-0)
Seal:	Nitrile butadiene rubber
Base:	Glass fiber reinforced PBT (UL94V-0)
Movable Contacts:	Beryllium copper with silver plating
Stationary Contacts:	Brass with silver plating
Terminals:	Brass with silver plating

Environmental Data

Operating Temperature Range:	-25°C through +70°C (-13°F through +158°F)
Humidity:	90 ~ 95% humidity for 240 hours @ 40°C (104°F)
Vibration:	10 ~ 55Hz with peak-to-peak amplitude of 1.5mm traversing the frequency range & returning in 1 minute; 3 right angled directions for 2 hours
Shock:	50G (490m/s ²) acceleration (tested in 6 right angled directions, with 5 shocks in each direction)

PCB Processing

Soldering:	Wave Soldering recommended. See Profile A in Supplement section. Manual Soldering: See Profile A in Supplement section.
Cleaning:	Automated cleaning. See Cleaning specifications in Supplement section.

Standards & Certifications

Flammability Standards:	UL94V-0 rated case & base The JB Series tactiles have not been tested for UL recognition or CSA certification. These switches are designed for use in a low-voltage, low-current, logic-level circuit. When used as intended in a logic-level circuit, the results do not produce hazardous energy.
--------------------------------	--

Distinctive Characteristics

Choice of dimensions from PCB to top of cap adds to design flexibility.

Bright, full-face illumination with red, green, or yellow LEDs for attractive, functional panel layouts.

Higher operating force type provides more pronounced operating feel.

Dome contact gives crisp tactile feedback to positively indicate circuit transfer and assures high reliability and long life of up to 5,000,000 operations.

Rubber seal construction prevents contact contamination and allows automated soldering and cleaning.

Slanted terminals provide a spring type action which ensures secure mounting and prevents dislodging during wave soldering.

Molded-in terminals are part of the sealed construction which allows automated soldering and cleaning.

Terminal spacing conforms to standard .100" (2.54mm) PCB grid.

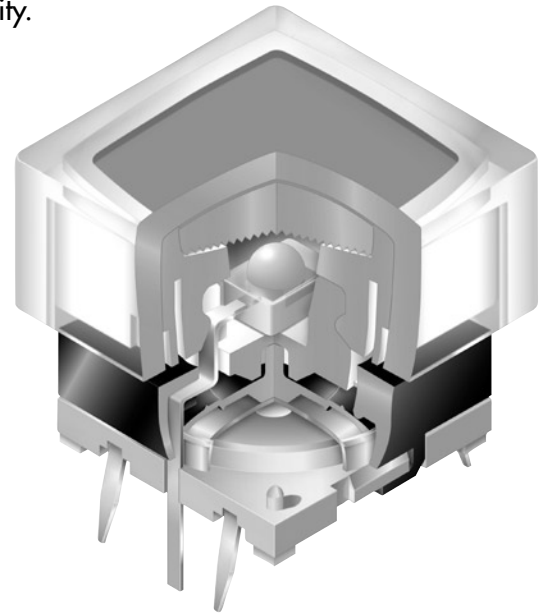

Actual Size

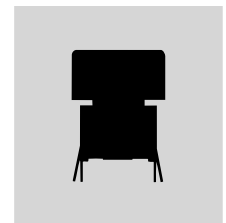

Common Bus Matrix

These single pole, single throw switches can be used in a keyboard matrix and, using strapped terminals, achieve a common bus electrical configuration on a single-sided PC board.

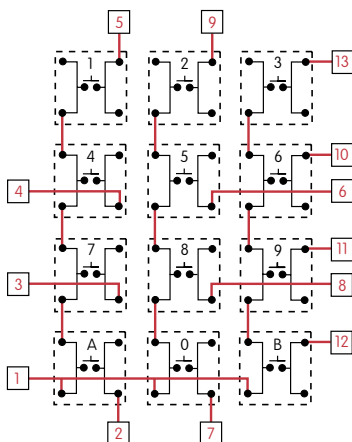

		PC Terminations												
		1	2	3	4	5	6	7	8	9	10	11	12	13
Keys (Switches)	1	●												
	2	●												
	3	●												
	4	●												
	5	●												
	6	●												
	7	●												
	8	●												
	9	●												
	0	●												
	A	●												
B	●													

● = ON

X-Y Matrix

These single pole, single throw switches can be arranged on a single-sided PC board matrix with strapped terminals to achieve an X-Y type electrical interconnection.

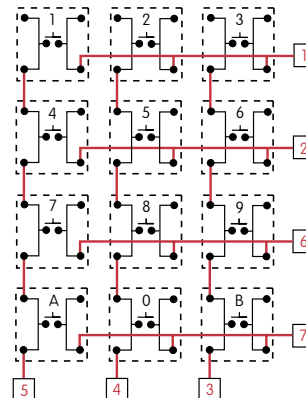

		PC Terminations						
		1	2	3	4	5	6	7
Keys (Switches)	1	●						
	2	●						
	3	●						
	4	●						
	5	●						
	6	●						
	7	●						

● = ON

Red = PCB Trace Black = Switch Circuit

TYPICAL SWITCH ORDERING EXAMPLE

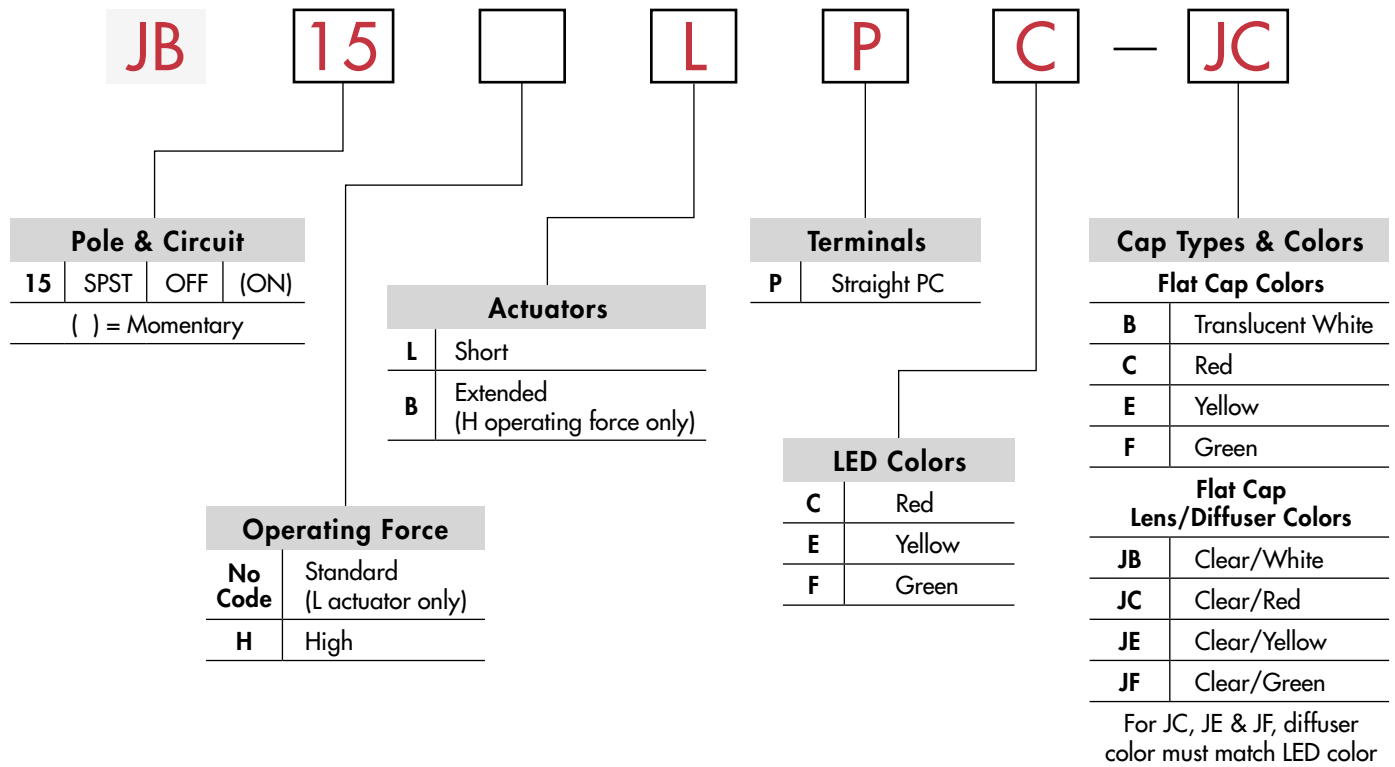

DESCRIPTION FOR TYPICAL ORDERING EXAMPLE

JB15LPC-JC

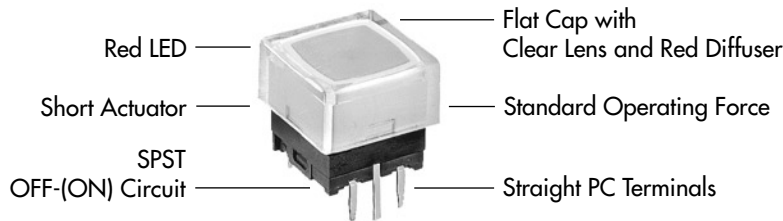

Framed Cap Button/Frame Colors	
BB	White/White
BC	White/Red
BE	White/Yellow
BF	White/Green
BH	White/Gray

POLE & CIRCUIT

Pole & Throw	Model	Actuator Position () = Momentary		Switch Throw & Schematic	LED Schematic	Notes: Terminal numbers are shown on switch. LED circuit is isolated & requires external power source.
		Normal	Down			
SPST	JB15	OFF	(ON)			

OPERATING FORCE

No Code

Standard Nominal Operating Force
1.76N

Available with short actuator only (code L)

H

High Nominal Operating Force
2.65N

Available with both short and extended actuators

ACTUATORS

L

Short Actuator

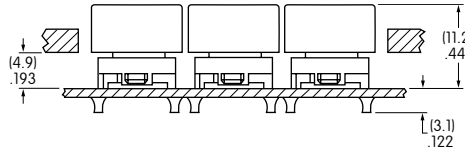
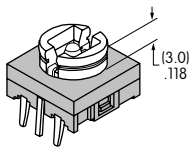

Custom keyboards can be designed with caps installed through a panel cutout (illustration with cap AT4060).

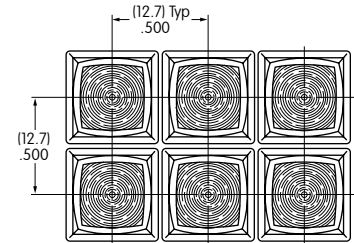

B

Extended Actuator

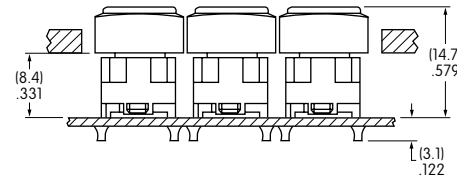
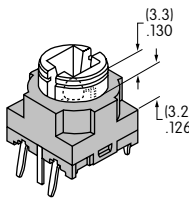

Custom keyboards can be designed with caps installed through a panel cutout (illustration with cap AT4076).

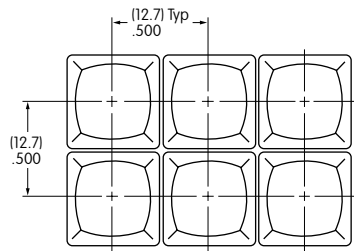

High operating force only

TERMINALS

P

Straight PC Terminals

Further details in Typical Switch Dimensions

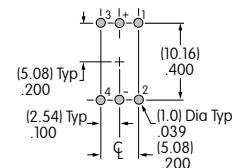
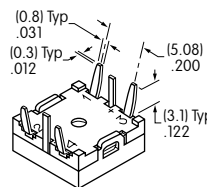

LED COLORS & SPECIFICATIONS

LEDs are supplied as an integral part of illuminated devices and are not available separately.

LED polarity markings are on the bottom of the switch.

The electrical specifications shown here are determined at a basic temperature of 25°C.

If the source voltage exceeds the rated voltage, a ballast resistor is required.

The resistor value can be calculated by using the formula in the Supplement section.

		C	E	F
Color		Red	Yellow	Green
Forward Peak Current	I_{FM}	25mA	25mA	25mA
Continuous Forward Current	I_F	20mA	20mA	20mA
Forward Voltage	V_F	2.0V	2.2V	2.1V
Reverse Peak Voltage	V_{RM}	4V	4V	4V
Current Reduction Rate Above 25°C	ΔI_F	0.42mA/°C		
Ambient Temperature Range		-25°C ~ +70°C		

SNAP-ON CAPS

AT4135 Flat

Cap Color Codes:

- | | | | |
|----------|--------------------------|----------|---------------|
| B | Translucent White | E | Yellow |
| C | Red | F | Green |

Material: Polycarbonate Finish: Frosted

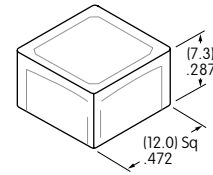

AT4060 Flat

Lens/Diffuser Color Codes:

- | | |
|-----------|--------------------------------|
| JB | Clear/Translucent White |
| JC | Clear/Red |
| JE | Clear/Yellow |
| JF | Clear/Green |

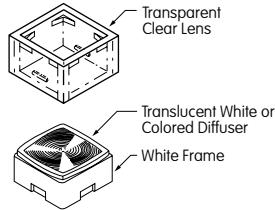
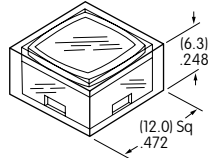

Framed: AT4076 Button with Frame

Translucent Button/Frame Color Codes:

- | | |
|-----------|---------------------|
| BB | White/White |
| BC | White/Red |
| BE | White/Yellow |
| BF | White/Green |
| BH | White/Gray |

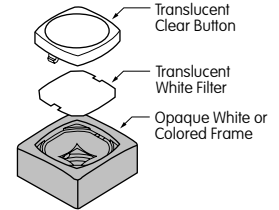
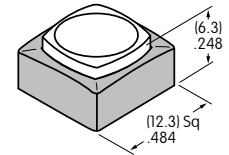

Material: Polycarbonate Lens Finish: Glossy Material: Polycarbonate Button Finish: Frosted

TYPICAL SWITCH DIMENSIONS

Flat Snap-on Cap

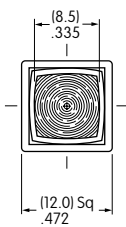

Short Actuator

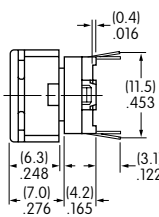

Extended Actuator

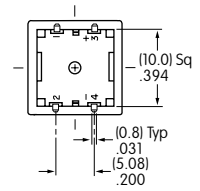
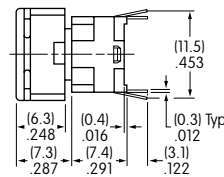

JB15LPC-JC

Spring action terminals conform to .100" (2.54mm) PCB spacing

Framed Snap-on Cap

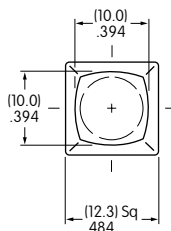

Short Actuator

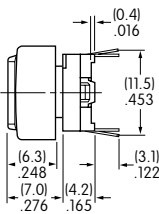

Extended Actuator

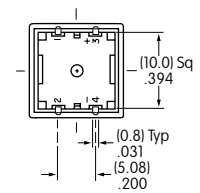
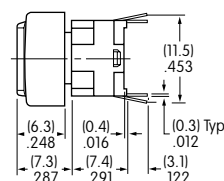

JB15HBPC-BC

Spring action terminals conform to .100" (2.54mm) PCB spacing

Toggles
Rockers
Pushbuttons
Illuminated PB
Programmable
Keylocks
Rotaries
Slides
Tactiles
Tilt
Touch
Indicators
Accessories
Supplement

LEGENDS

NKK Switches can provide custom legends for caps. Contact factory for more information.

Suggested Printable Area for Cap, Lens, or Button

Recommended Methods:

Laser Etch, Screen Print or Pad Print

Laser Etch or Pad Print

Epoxy based ink is recommended.



Epoxy based ink is recommended.

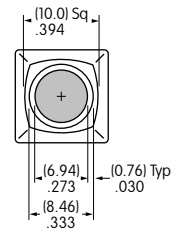
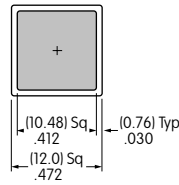
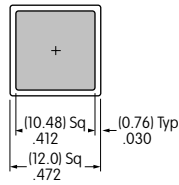

Shaded areas are printable areas.

Suggested Printable Area for Film Insert

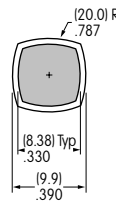
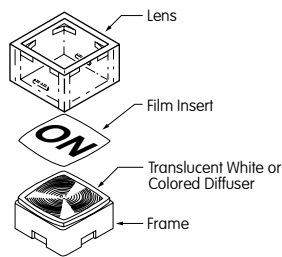

Shaded area is printable area.

Film Insert: Clear Polyester 7 mil maximum thickness